

# Manually operated console minivalves Series 2

3/2 and 5/3-way CC CO CP  
Ports M5, Cartridge Ø 4



This series of miniature valves has been specially designed to satisfy all the application requirements of the controls industry with particular attention paid to the operating characteristics required from these components:

- Short operational stroke
- Small dimensions

## GENERAL DATA

<b>Valve group</b>	3/2-way
<b>Construction</b>	poppet-type (closed centres)
<b>Materials</b>	aluminium body, brass plunger, NBR seals
<b>Mounting</b>	panel
<b>Ports</b>	M5 or cartridge dia. 4
<b>Ambient temperature</b>	0°C + 60°C
<b>Medium temperature</b>	0°C + 50°C
<b>Operating pressure</b>	see models

**CODING EXAMPLE**

<b>2</b>	<b>3</b>	<b>4</b>	<b>-</b>	<b>97</b>	<b>5</b>
----------	----------	----------	----------	-----------	----------

<b>2</b>	SERIES
<b>3</b>	FUNCTION: 3 = 3/2-way NC 4 = 3/2-way NO 8 = 5/3-way CO (function realized with 2x 3/2-way NC valves)
<b>4</b>	PORTS: 4 = cartridge $\varnothing$ 4 5 = M5
<b>97</b>	MODE OF OPERATION: 87 = 3 position selector 89 = push button 97 = palm switch 90 = joystick 99 = 2 position selector 92 = pedal 904 = key
<b>5</b>	RESETTING: 5 = spring return 0 = stable 2 = latching-twist to release 54 = joystick

**2**

CONTROL

**Minivalves**

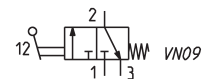
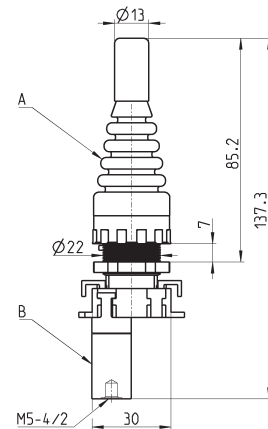
 Operating pressure = 2 ÷ 8 bar  
 Flow rate = 60 NI/min.

Mod.	A	B
<b>234-905</b>	200-905	234-000
<b>235-905</b>	200-905	235-000

Minivalves

Operating pressure = 2 ÷ 8 bar  
Flow rate = 60 NI/min.

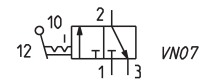
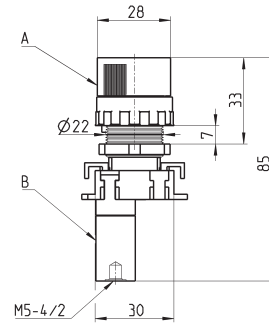

Mod.	A	B
<b>234-990</b>	200-990	234-000
<b>235-990</b>	200-990	235-000

Minivalves

Operating pressure = 2 ÷ 8 bar  
Flow rate = 60 NI/min.  
Actuating force at 6 bar = 7 N

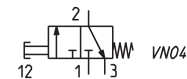
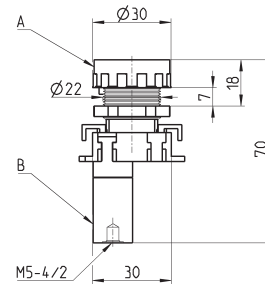

Mod.	A	B
<b>234-895</b>	200-895	234-000
<b>235-895</b>	200-895	235-000

Minivalves

Operating pressure = 2 ÷ 8 bar  
Flow rate = 60 NI/min.  
Actuating force at 6 bar = 7 N

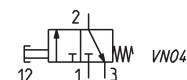
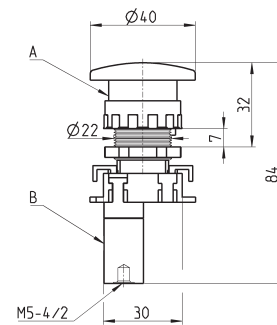

Mod.	A	B
<b>234-975</b>	200-975	234-000
<b>235-975</b>	200-975	235-000

**Minivalves**

Operating pressure = 2 ÷ 8 bar  
 Flow rate = 60 NI/min.  
 Actuating force at 6 bar = 7 N

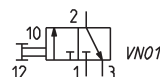
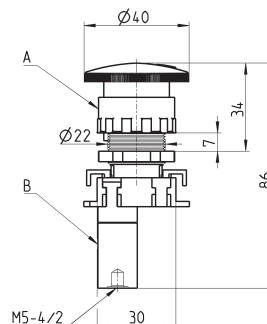

Mod.	A	B
<b>234-972</b>	200-972	234-000
<b>235-972</b>	200-972	235-000

**Minivalves**

Operating pressure = 2 ÷ 8 bar  
 Flow rate = 60 NI/min.

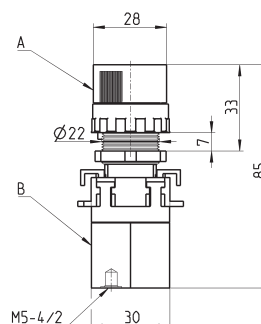

Mod.	A	B
<b>284-870</b>	200-870	284-000
<b>285-870</b>	200-870	285-000

**Minivalves**

Operating pressure = 2 ÷ 8 bar  
 Flow rate = 60 NI/min.

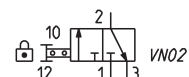
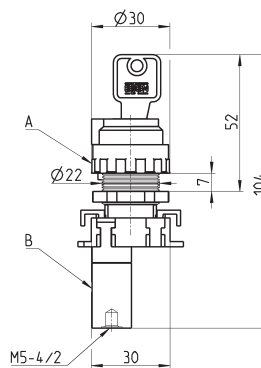

Mod.	A	B
<b>234-904</b>	200-904	234-000
<b>235-904</b>	200-904	235-000

Joystick valves

Minimum pressure = 2 bar

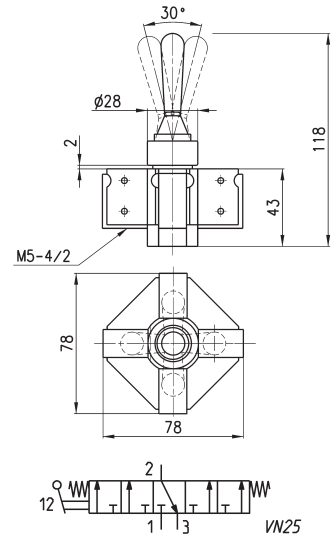

Mod.  
234-9054  
235-9054

Minivalves

Operating pressure = 2 ÷ 8 bar  
Flow rate = 60 NI/min.

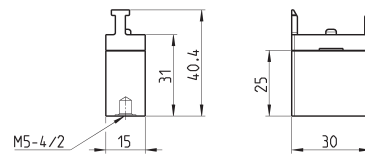

Mod.  
234-000  
235-000

Minivalves

Operating pressure = 2 ÷ 8 bar  
Flow rate = 60 NI/min.

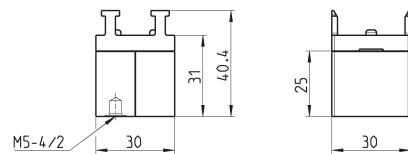

Mod.  
284-000  
285-000

Drilling for mounting

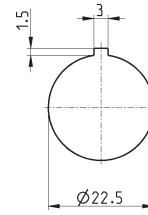

Adaptor

Panel hole adaptor Ø30  
Supplied with:  
2x reduction rings

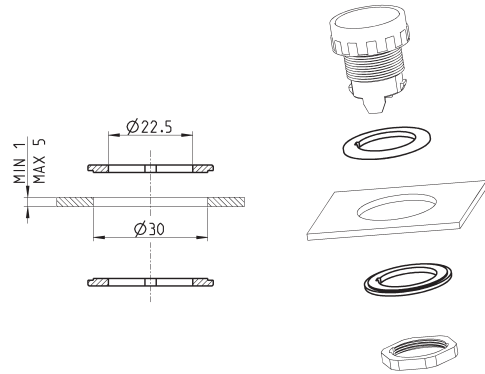

Mod.  
200-2230

End cover

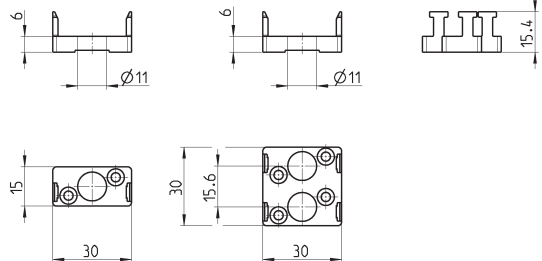

Mod.  
210-000  
220-000